

OZAAS SMART DEVICES

CONTROL YOUR LIGHTS AND APPLIANCES FROM
ANYWHERE WITH YOUR SMARTPHONE

+16 Million Colours



Works with



Google Home



amazon alexa

WELCOME TO YOUR INTELLIGENT WORLD

With just a tap on your smartphone, remotely turn on your lights or brew your coffee from bed. Or set schedules for all your appliances and spend more time doing the things you love. How smart is that?

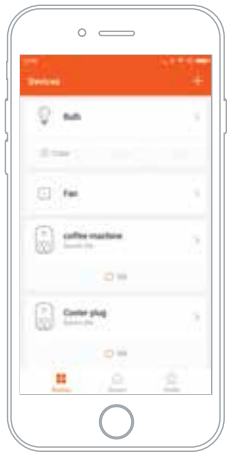

 **REMOTE ACCESS**
Remotely control your smart devices with the Ozaas Smart App.

 **SMART TIMER**
Easily set timers on your smart devices to match your daily routine.

 **SCHEDULING**
Schedule devices to automatically turn on/off as needed.

 **CREATE SCENES**
Set your favourite colour configurations or device function as scenes and recall them with a tap.

 **GROUPING**
Group lights and appliances on your app and control them all at once.

Create Personalized Scenes



OZAAS®

CONTROL YOUR LIGHTS AND APPLIANCES FROM ANYWHERE WITH YOUR SMARTPHONE

 No complex wiring

 Easy to use interface

 Intelligent



Download the free Ozaas Smart app for iOS & Android



Works with

 Google Home  amazon alexa

NO HUB REQUIRED

Smart LED Bulb



Smart Camera



Smart Light Strip



Smart Plug



Smart Wall Switch



OZAAS Smart makes your home secure, comfortable and smart. Live smarter with OZAAS.





REMOTE MONITORING

Control your home from anywhere

Get complete peace of mind with Ozaas Smart Devices. Control appliances connected to the Smart devices using the free Ozaas app on your Android or iOS smartphone.



Download the free Ozaas Smart app for iOS & Android





SCENES & GROUPING

Create & Customize

Create personalized scenes for your devices or group multiple devices and activate them all at once with your smartphone or an Alexa voice command.

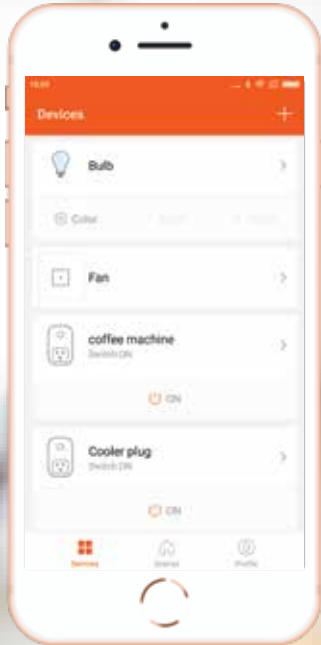

Morning Scene

Turn on the coffee machine + Turn off the porch lights

Away Scene

Randomly have your lights turn on and off to simulate your presence

Im home Scene

Turn on the music system + Turn on cool blue + Turn on porch lights

Party Scene

Turn on party mode with multiple colours cycling through



VOICE CONTROL

Go Hands Free

Pair your OZAAS Smart devices with voice assistants - Amazon Alexa & Google Home and control your lights appliances with your voice.

“ Alexa, turn on the living rooms lights”

“OK”

Works with



Google Home



amazon alexa





SCHEDULING & TIMERS

Simple Everyday Conveniences

Schedule your lights and appliances to automatically power on and off as needed. The smart timer mode lets you turn the device on for a set time period.



**Set 180°C
at 5:30pm**



**Lights Dimmed to
20% at 5:30 pm**



**1 hour
Cooling at
22°C scheduled**



**Smart
Timer
7:00 am**



WiFi

OZAAS SMART WI-FI PLUG

Keeps you connected to your appliances



WI-FI
ENABLED



REMOTE
MONITORING



SCHEDULING



SMART
TIMER



SHARE
CONTROL



CUSTOMIZE
SCENES



VOICE
CONTROL

Use your smart phone to control



Lights



Oven



Heater



Fan



Refrigerator



Coffee
Machine



and
more..

SPECIFICATION

Working Voltage : AC 110~240V

Max Power : 2000W (resistance loading)

Working Current : Max 10A

Material : ABS flame retarding polymer

Plug Standard : UK

Power Consuming : $\leq 0.3W$

Working Temperature : $-20^{\circ}\sim 45^{\circ}C$

Working Humidity : $\leq 80\%$

Radio signal Power : 1mW

Radio Protocol : Wi-Fi

Radio Rate : 30 meter indoor

Radio Rate : 50 meter outdoor

EASY TO SET UP



1. Download the free
Ozaas Smart App



2. Plug in the Smart
Wi-Fi Plug in an outlet



2. Configure Smart
Wi-Fi plug on the App



Get complete control of connected appliances from anywhere



Control and automate any appliance without getting out of bed.



Gives you the peace of mind that you'll never leave any appliance turned on while away.



Schedule your air purifier to turn on at a specific time so fresh air welcomes you home.



Turn on the cooker remotely and enjoy warm dinner by the time you come home.



Create On/Off Schedules for your Smart Plug
Set your devices to work for you whenever you want



Turn Devices On/Off with free Ozaas Smart App
Instantly turn devices on or off from your smartphone or tablet



WiFi

OZAAS SMART WI-FI WALL SWITCH

Choose from over 16 Million colours



WI-FI
ENABLED



REMOTE
MONITORING



SCHEDULING



SMART
TIMER



SHARE
CONTROL



CUSTOMIZE
SCENES



VOICE
CONTROL

Note : Neutral wire is required to install this switch

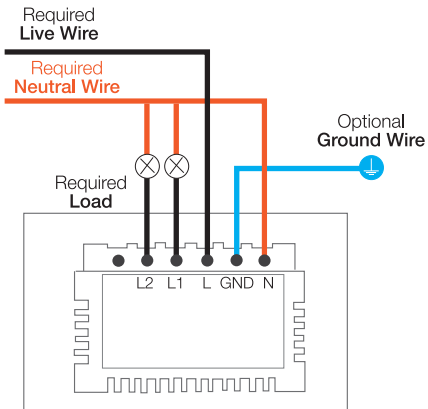

SPECIFICATION

Panel Material : Crystal tempered glass panel
Operating Voltage : AC110V-240V/50Hz~60Hz
Rated Load : Each gang less than 300W
Power Consumption : Less than 1mA
Working Temperature : -20 ~ 50°C
Life Span : More than 100,000 times
Switch Standard : Available in UK / US
Capacitive touch
LED Indicator
Neutral wire required





OZAAS SMART WI-FI LED BULB

Choose from over 16 Million colours



WI-FI
ENABLED



REMOTE
MONITORING



SCHEDULING



SMART
TIMER



SHARE
CONTROL



CUSTOMIZE
SCENES



VOICE
CONTROL

SPECIFICATION

Working Voltage : AC 110~240V

Humidity: ≤80%

Working temp: -5~45 degree's

Material: PC + Aluminum

Light Color: Warm White

Connector Type: E27 / B22 / IN

Voltage: 110V -240V

Frequency: 50-60Hz

Luminous Flux: 400LM

Light Effect: 85LM/W

Life Span: 50000h



FAST & EASY SET UP

Step 1 Download & install OZAAS Smart App



Available on the
App Store

GET IT ON
Google Play

Step 2 Plug in your OZAAS Smart Bulb

Step 3 Open your OZAAS Smart App, add the Smart bulb and follow app instructions



+16 Million Colours



LED Controller included

WiFi

OZAAS SMART WI-FI LED LIGHT STRIP

Choose from over 16 Million colours



WI-FI
ENABLED



REMOTE
MONITORING



SCHEDULING



SMART
TIMER



SHARE
CONTROL



CUSTOMIZE
SCENES



VOICE
CONTROL

FAST & EASY SET UP

Step 1 Download & install OZAAS Smart App



Available on the
App Store

GET IT ON
Google Play

Step 2 Connect the LED Controller to the light strip and power it on.



Step 3 Open your OZAAS Smart App, add the LED strip device and follow app instructions

LED LIGHT STRIP SPECIFICATION

Input Voltage : 12V (5~28V)

Input Voltage : 12 ~24V

Rated Power : 14.4W

Max Current : 12A

Working Temp : -20° ~ 60° C

LED CONTROLLER SPECIFICATION

Wiring Mode : Two 5 PIN output

Strip Length : 5 meters

Colour : Warm white



OZAAS Smart Lighting

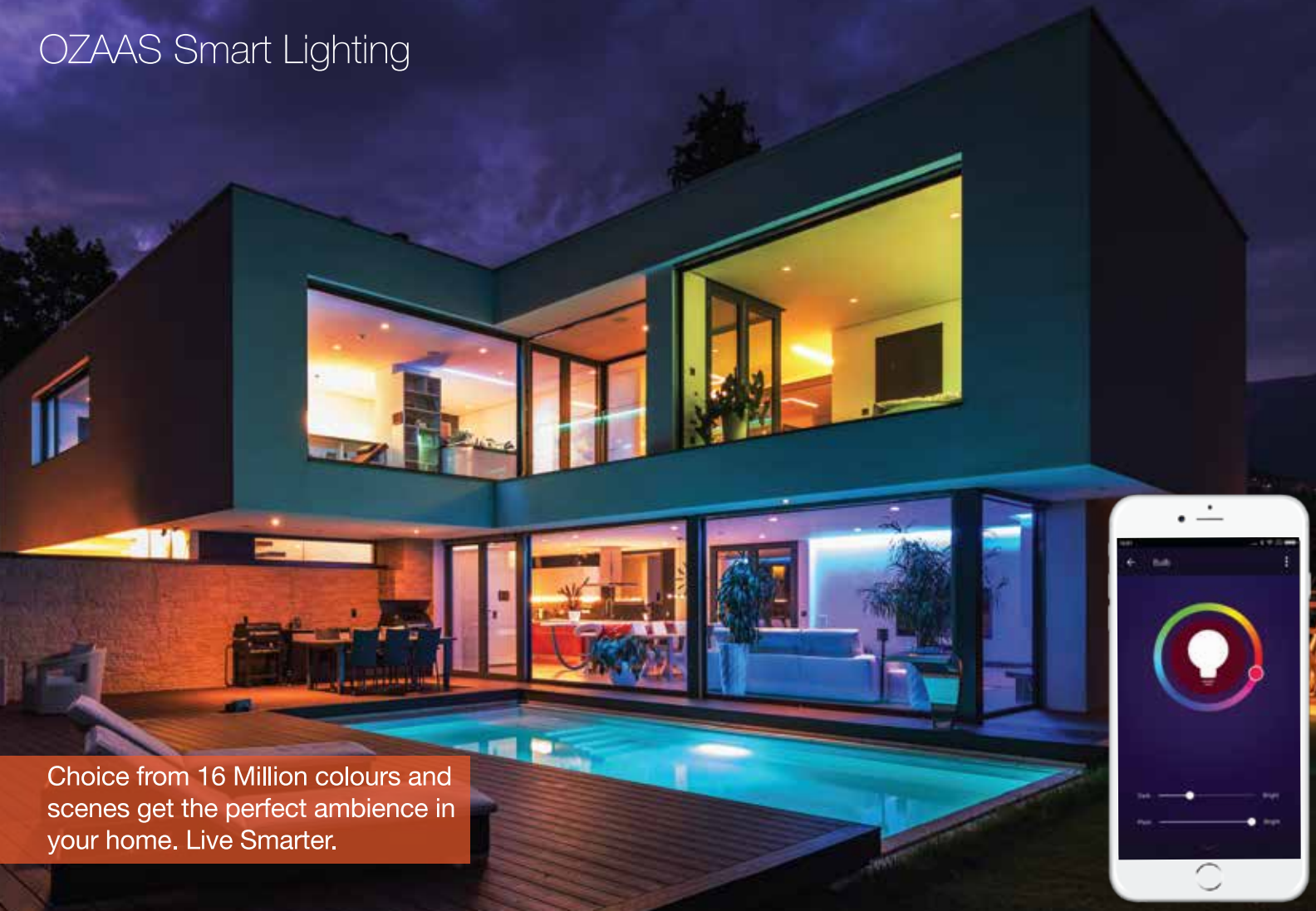

Choice from 16 Million colours and scenes get the perfect ambience in your home. Live Smarter.



MAKE YOUR WORLD SMARTER, WITH JUST A TAP

Manage all your smart devices with one App. Control your switches, lights, heater, air con and more with just your smartphone. A tap or two is all you'll ever need to check-in.
The free Ozaas app is available for iOS and Android



Download the free Ozaas Smart app for iOS & Android



OZAAS[®]SMART

www.ozaas.com | info@ozaas.com